

# CHRONOSKOP CHR-7

The timegrapher

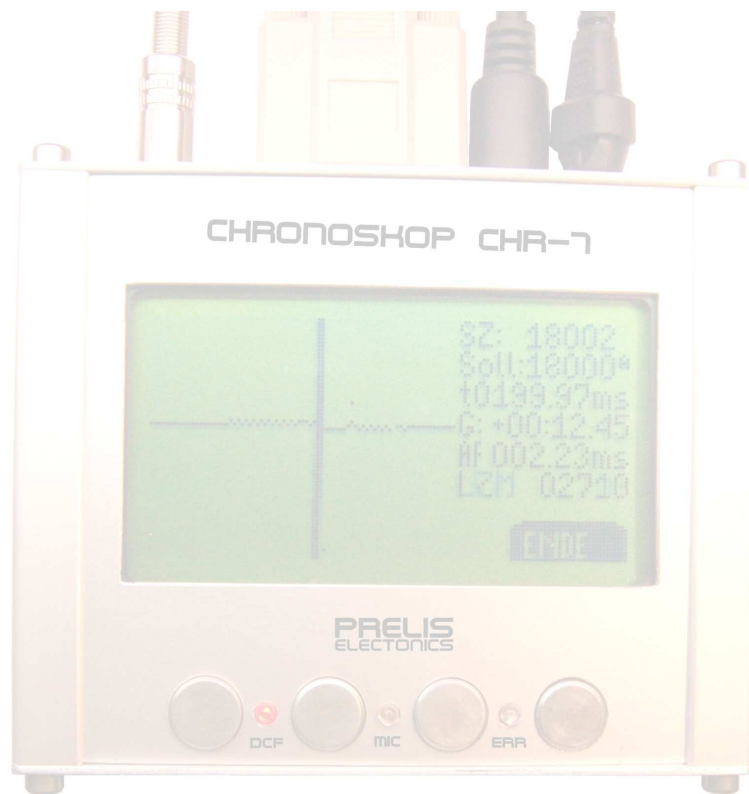

Instruction manual

© 2007 [www.CHRONOSKOP.de](http://www.CHRONOSKOP.de)



---

## Index

<b><u>1. INTRODUCTION.....</u></b>	<b><u>4</u></b>
1.1. GENERAL INFORMATION ON THE DEVICE FUNCTION .....	4
1.2. ABOUT THE CALIBRATING WITH DCF77 RADIO SIGNAL.....	5
1.3. CONNECTION AND COMMISSIONING.....	6
<b><u>2. THE ASSEMBLY OF THE MENU .....</u></b>	<b><u>8</u></b>
<b><u>3. MEASURE WITH THE TIMEGRAPHER .....</u></b>	<b><u>9</u></b>
3.1. MEASUREMENT OF HAND WATCHES .....	9
3.2. MEASUREMENT OF PENDULUM CLOCKS .....	10
3.3. SETTING THE MICROPHONE SENSITIVITY .....	10
3.4. SETTING THE BEAT NUMBER.....	11
3.5. THE MEASUREMENT - THE TIME AXIS VIEW.....	12
3.6. GRAPHICAL ANALYSIS – DIAGRAM VIEW .....	13
<b><u>4. CALIBRATING THE QUARTZ FREQUENCY .....</u></b>	<b><u>15</u></b>
<b><u>5. OUTPUT OF DEVICE INFORMATIONS .....</u></b>	<b><u>16</u></b>
5.1. DEVICE INFORMATIONS.....	16
5.2. LAST MEASURE .....	16
<b><u>6. PC-SOFTWARE „CHRONOPORT“ .....</u></b>	<b><u>17</u></b>

---

# 1. Introduction

## 1.1. General information on the device function

Chronoskop is a fully electronic timegrapher for measuring mechanical clocks. For measure is used the acoustic signal of a clock. Values to be measured are rate, beat number, beat error and period time. For evaluation can be used the time axis view or diagram view. All of the measurement information will be displayed on the illuminated graphic display. The calibrating of the crystal frequency with the radio signal of the atom clock in Mainflingen (Germany) can realize an accuracy of some seconds per Year. In that way it is possible to reach an accuracy, that would otherwise be possible to realize only with great effort of technology. The application of new microcontroller technology and use of modern SMD technology allows a compact solution, that can be compared with expensive large device. Compact design (about 9cm x 11cm x 4cm) gives the device handiness, it is easy to transport and can be widely used.

The device comes with external microphone supplied piezo, which allows a measurement of clocks in various locations and the gauging clock. The microphone casing is made of stainless steel. To decouple the noises the piezo disc is placed on 10 mm foam. Because of the high sensitivity of the microphone, surrounding noises should be avoided (despite digital filtering). A rotary knob allows to adjust the sensitivity of the piezo microphone. The beats can be detected automatically, manually or can be chosen from a table of the beats.

The measurements can be sent via a serial interface to a PC where they can be stored or printed. The device works of course, even without a PC. The device should only be operated indoors.

The device use is only allowed in closed environment. For the power supply must be used only the AC power supply or optionally available external battery pack. Occupancy of the plug: positive DC 9V on the pin, ground on the outside.

## 1.2. About the calibrating with DCF77 radio signal

The calibrating of the internal quartz results from comparison with the radio signal of the atomic clock in Mainflingen near Frankfurt Main (Germany). DCF77 is a time signal emitted on the long radio wave. DCF77 is emitted on the 77.5 kHz frequency as time information in coded form and has a broadcast range of about 2000 km in radius around Mainflingen. In DCF77 signal is the time of the next minute coded. The DCF77 signal is the definition of "right time" of Germany.

The device is calibrated before shipping. If measurement takes place in room ambient temperature, a re-calibration is not necessary.

**ATTENTION!** The reception of the signal is depending on location and is not guaranteed outside of Germany!The reciver is not always included and must be possibly ordered separately.

### 1.3. Connection and commissioning

The device has 3 LEDs, attached under the LCD display. From the left:

- Error or incorrect signal during the measuring or calibrating (red)
- Signal of a piezo microphone (green)
- Signal of the radio receiver (yellow)

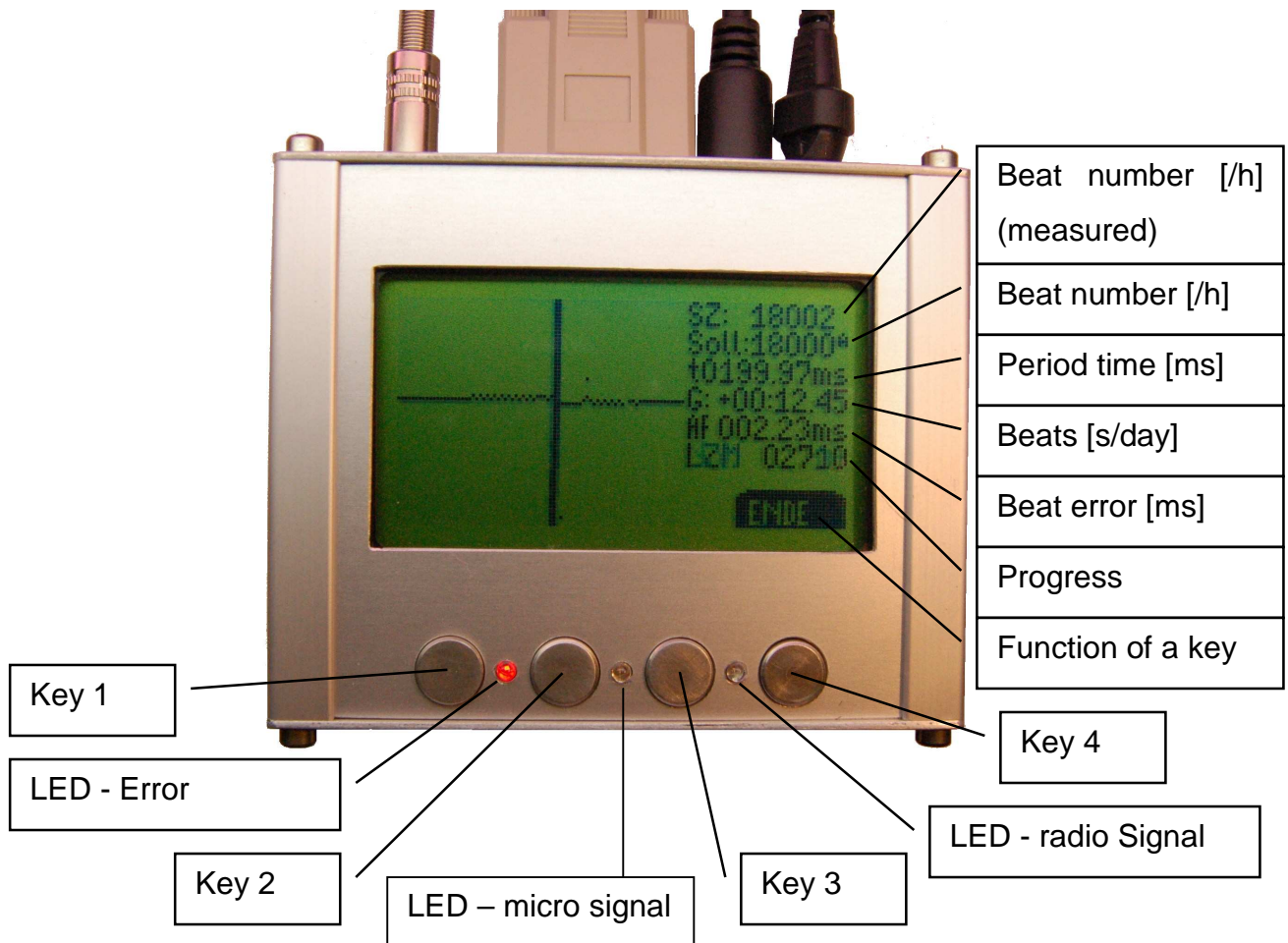

The function of the four keys below the display is always described bright letters on a dark background, always next to the button. A button without a label given moment has no function.

The device includes the following lines:

- Power supply
- Microphone port
- Serial Interface
- Radio receiver (DCF-77) connector (4-pin Mini-Din socket)

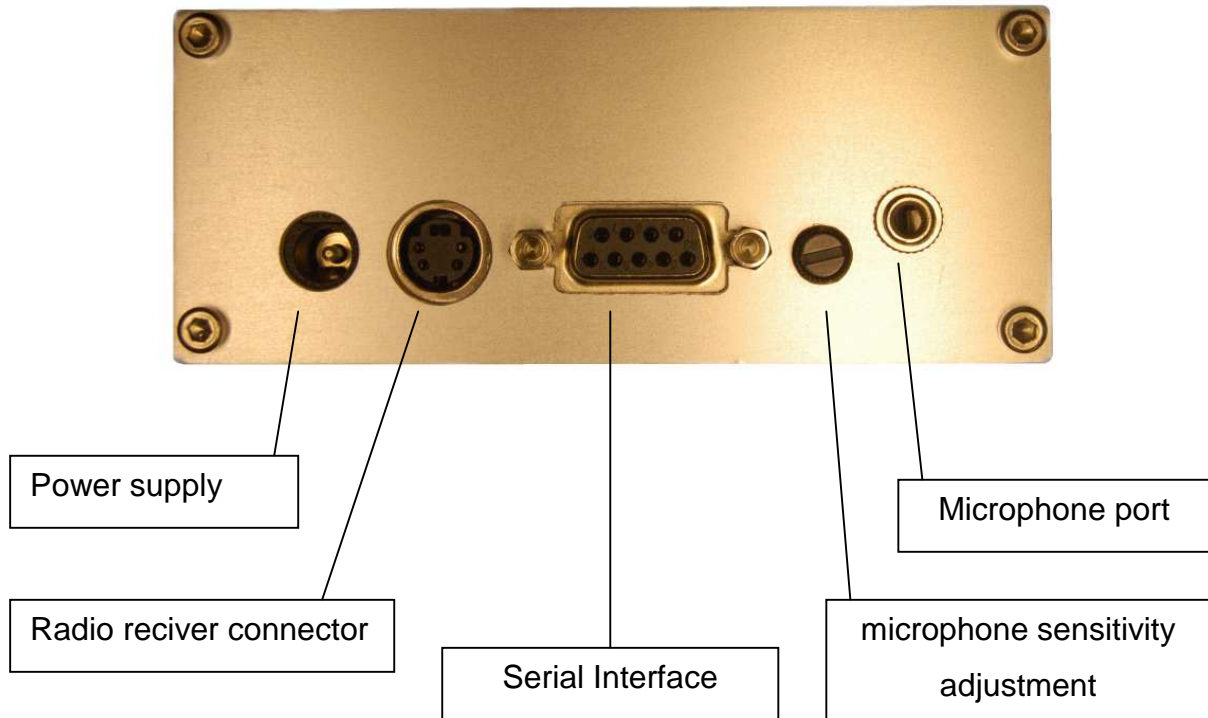

Commissioning of the unit should be considered in the ambient temperature in which the instrument has been calibrated (see chapter "calibration").

## 2. The assembly of the Menu

The following is an overview of the menu assembly:

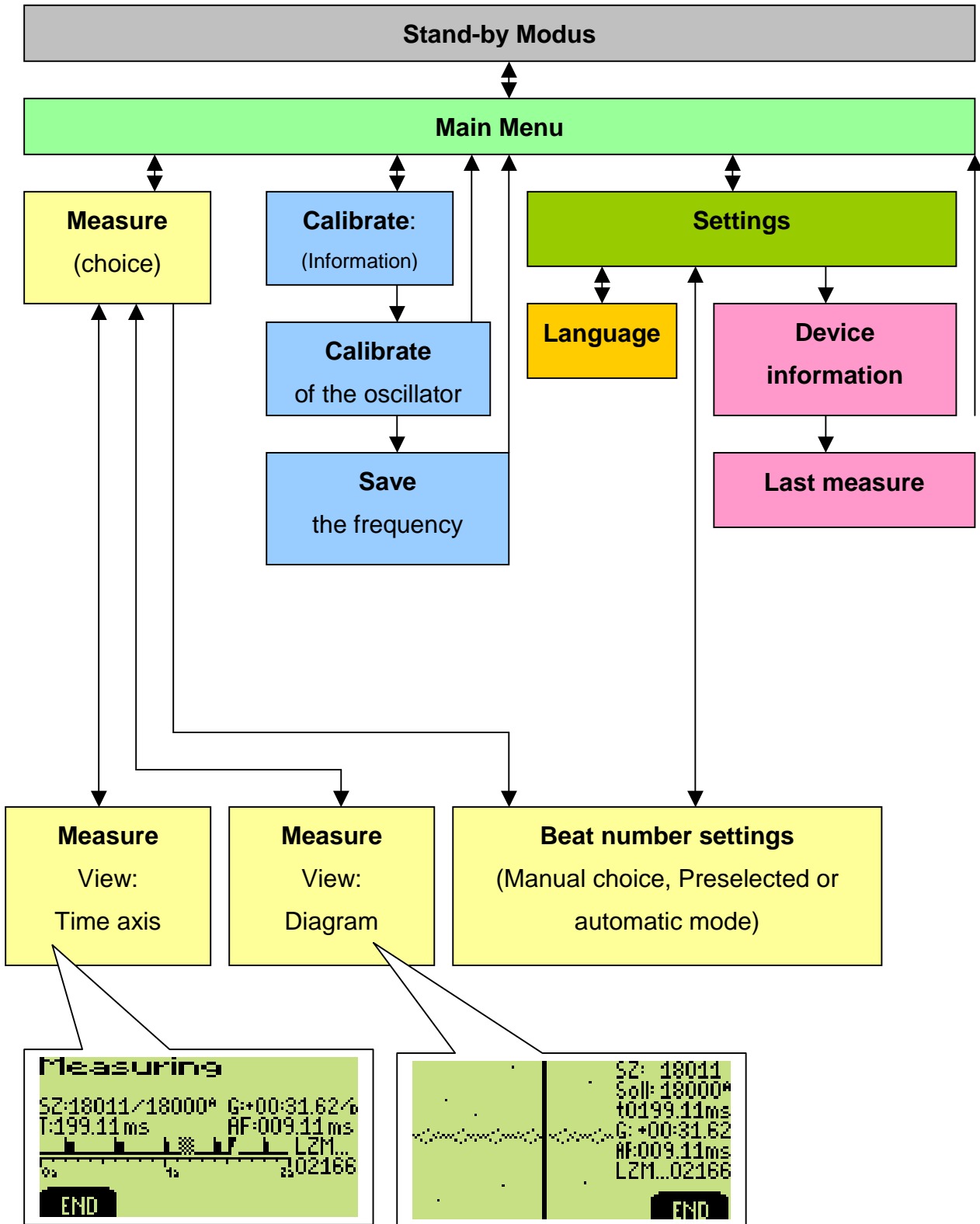



### 3. Measure with the timegrapher

At the microphone port may be connected only the provided piezo microphone. Is it protected with a cap, that must be removed before the measurement. Because of the sensivity of the piezo cristal, the microphone must be protected against mechanical damage.



#### 3.1. Measurement of hand watches

To measure a hand clock or a small clock lay the it on the piezo microphone like shown on the picture. To recice the vibrations of a clock optimally, the housing of a clock should the clock should contact to the microphone surface directly. Measure clocks with this piezo microphone up to 200 g!



Although the Piezoscheibe of the microphone is made of soft metal, the clock should be positioned with caution in order to avoid any scratches.

### 3.2. Measurement of pendulum clocks

For measure of a pendulum clock, put the microphone carefully on a solid body of the clock upside down. Make sure the detecting side of the microphone to connect the housing of the pendulum clock. On clock with closed housing it is recommended to put the microphone inside the housing. During the measure turn of the bell of a clock to avoid disturbances during the measurement.



### 3.3. Setting the microphone sensitivity

The at the rear mounted rotary knob allows to adjust the sensitivity of the microphone. It should be noted that none of the stops results with a full scale of the signal on the axis or diagram. The best result is achieved in about the middle of the rotation range.

It is recommended to set the sensitivity during the measurement with the time axis, where the length of the digital signal can be recognized (see "The measurement - the time axis"). When removing the clock the impulses should disappear. Noise of the overloaded amplifier can generate periodic oscillation, which will be interpreted as clock impulses. It is also important, to avoid rushing noise (for example, the noise of the fan noise of the computer). These are invisible on the diagram, however, reduce the sensitivity of the device significantly.

### 3.4. Setting the beat number

If no beat number selected manually, the timegrapher works in automatic mode and detects during the measure the nearest beat number from the table stored in the device. These are: 3600, 6000, 7200, 9000, 12000, 14400, 17280, 18000, 19800, 21600, 27000, 28800 and 36000. In automatic beat number detect mode there is a small "A" beside the target beat number during the measurement.

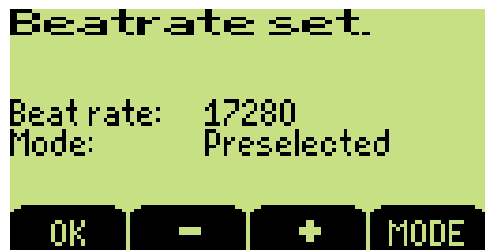

The beat number can be selected manually. In menu "beat number setting" there can be chosen between:

- Automatic (Automatic detect of the beat number)
- Preselected (Choose one of default beat numbers)
- Manual choice (Individual setting of the beat number)

The mode can be switched by pressing key 4. Keys described with "+" and "-" decrease and increase the beat number. These buttons do not have any function in automatic mode.

### 3.5. The measurement - the time axis view

During the measurement with the time axis the signals will be displayed on the time axis. The axis will go through in 2 seconds. The smallest division represents 100 ms. After a periodic incoming signal is detected, the measurement starts automatically. The signal is displayed as short dark stripe, which noise against gray spotted.

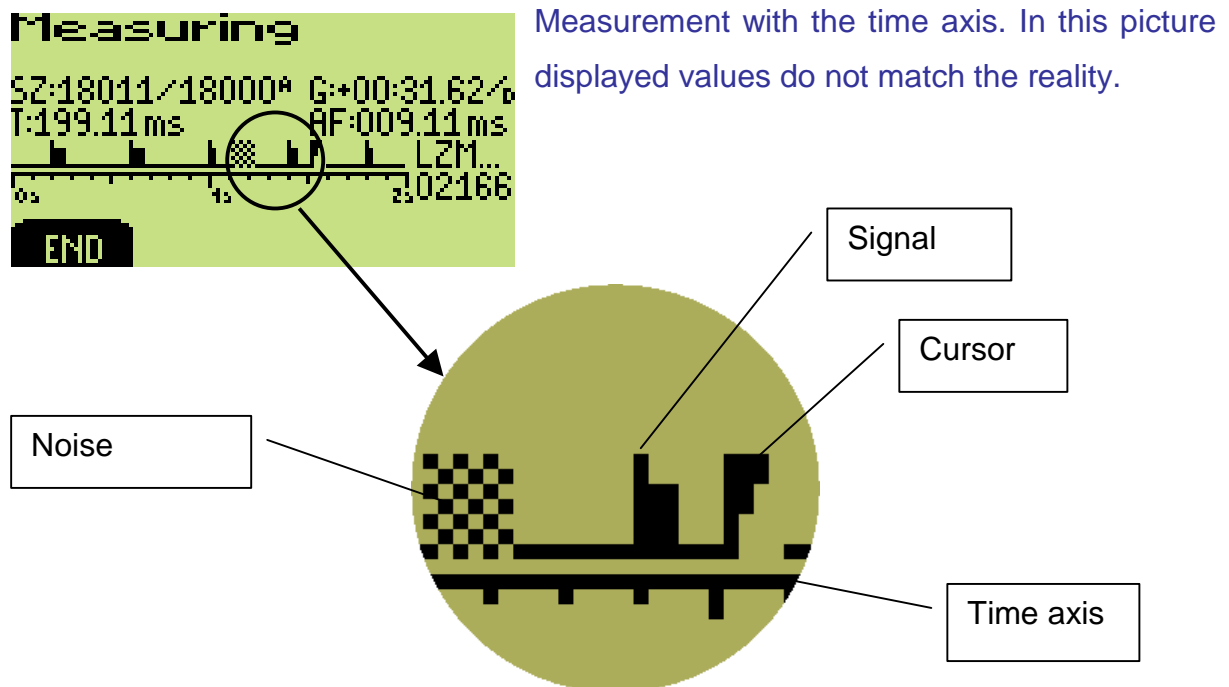

Above the time axis issued values:

Calculated beat number [ /h ] / Must value of the beat number [ /h ]

Pulse duration [ ms ]

Rate [ mm:ss.ff / 24h ]

Beat error [ ms ]

In the lower right corner will be issued the number of strokes used for calculation. If an error occurs during the measurement or no periodic signal detected, the red LED lights on.

Regard! Because the entire measuring time is integrated for measuring, the measurmet should be started new after every regulate of a clock!

### 3.6. Graphical analysis – Diagram view

When measuring with a graphical view, the values are displayed on the right side of the display. These are the same values, as in the measurement with the time axis.

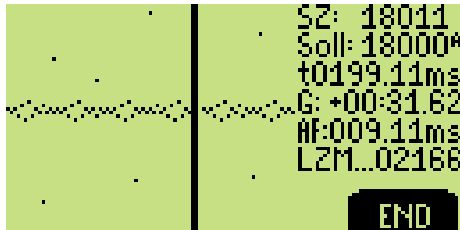

Measurement with the diagram view. In this picture displayed values do not match the reality.

The following part shows some examples of errors. These are the idealized representations and should be used only for guidance. In reality usually several errors occur simultaneously.

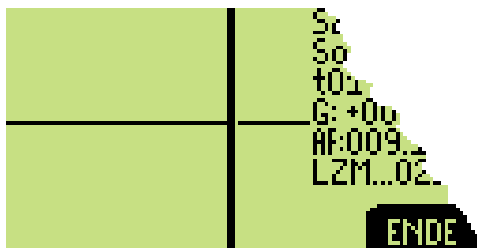

Ideal clock

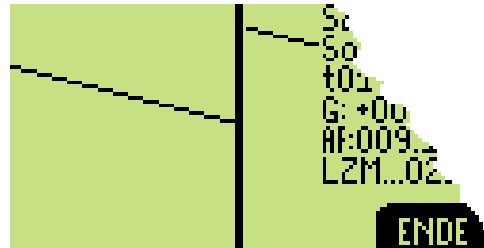

Delay

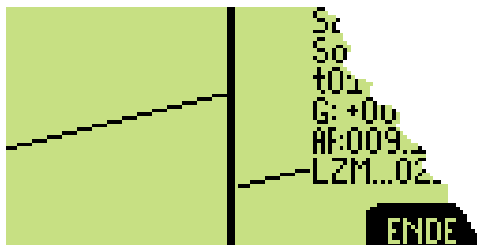

Clock is too fast

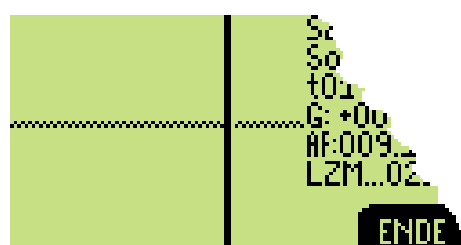

Light beat error

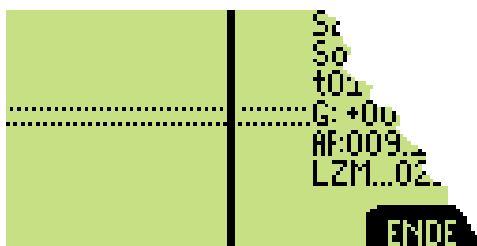

Larger beat error

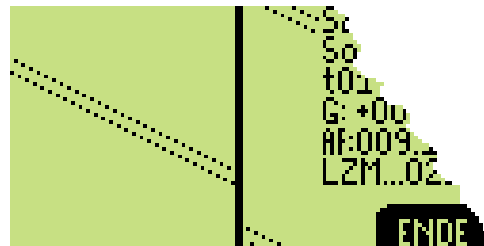

Beat error with delay

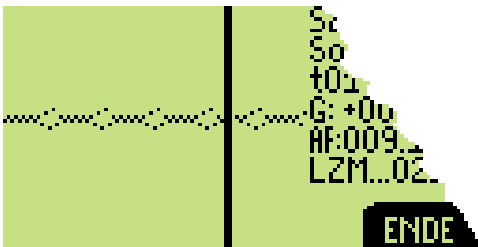

Periodic error

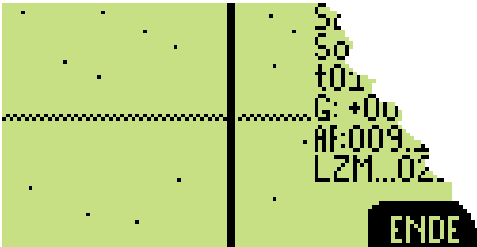

Noise

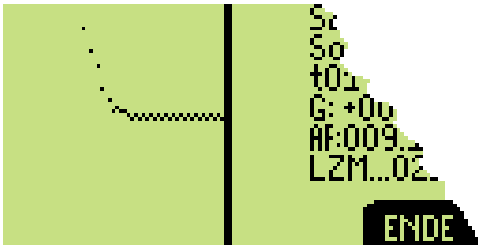

Swing-into of a clock

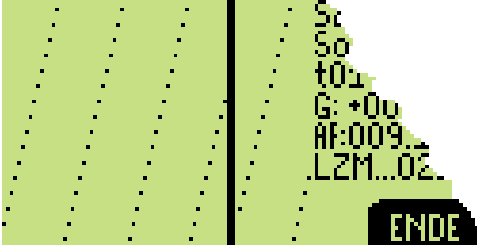

Wrong beat number selected

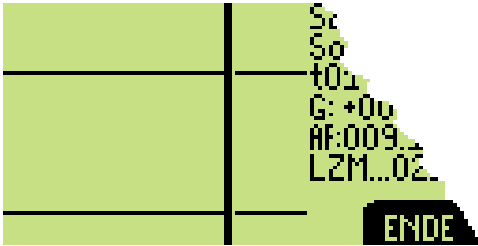

Selected beat number too small

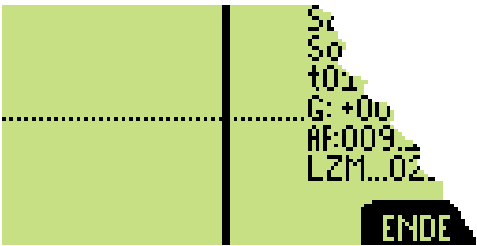

Selected beat number too big (2x)

## 4. Calibrating the quartz frequency

Calibrating the quartz frequency can be choosed directly from the main menu. To calibrate connect the radio reciver to the 4-pin Mini-Din socket with the provided cable. For a better recive in enclosed spaces, the reciver should be placed close to a window. The reciver is not allways added to the set.



**ATTENTION!** The reception of the signal is location outside of Germany and is not guaranteed! Neither the timegrapher nor the reciver should be connected to other devices with with S-Video port! Danger of a destruction!

After connecting the radio reciver the calibrating starts automatically. The following values are displayed:

Current quartz frequency

Measured pulse duration of the DCF77 signal [s] (ideally: 1,000 s)

Calculated quartz frequency

Accuracy achieved [s / year]

In the lower right corner, the number of pulses counted.

```
Calibrate
fold 16000000 Hz  tPER 1.008 s
fnew 16008347 Hz ±0162 s/year
████████████████████ DCF77
0%          1s          2,02156
END SAVE
```

The accuracy of each second time signals is dependent of location and environmental factors. Therefore the calibration should last at least one hour. It is recommended to calibrate 12 hours.

The determined frequency and the deviation during the calibration is always displayed on the screen. With the key 2 the determined frequency can be stored. This keypad will not appear until fairly good accuracy.

## **5. Output of device informations**

### **5.1. Device informations**

In this menu you have an access to some information from the device. Available informations are listed below:

- Version of the software
- Version of the hardware
- Original frequency of the oscillator
- Oscillator frequency after calibration

If the device has never been calibrated, appropriate information will be displayed.

### **5.2. Last measure**

Here you have the opportunity to output data of the last measurement. These data will be deleted with the disconnect of power supply. At the same time the measure raport will be send to the PC via the serial interface.



## 6. PC-Software „Chronoport“

With the attached software "Chronoport", the measurement data can be sent to the computer to be saved or printed. The operating system "Windows" is required. If the system does not have the latest updates, "Microsoft .NET Framework" must be downloaded from the Microsoft <sup>TM</sup> Internet site and installed.

In order to use the software, a serial interface on the computer is needed. If no serial interface on the PC, use USB adapters. This is widely available in trade. It can also be ordered optionally.

The data are for each measurement automatically sent to the computer. It can also be sended later, as long, as the device has not been disconnected from the supply.

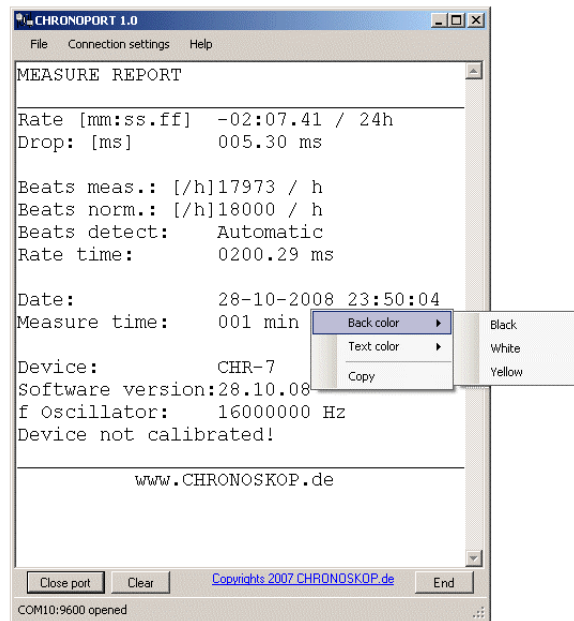

In the menu "File" the the content of the text field can be saved as a text file or printed on a printer.

With "end" the program will be closed.

In the menu "Connection settings" you can change the settings of the serial connection. In the top selection, the port you can choose a port to communicate. The other fields should remain unchanged. With the "default" the preferences can be restored.

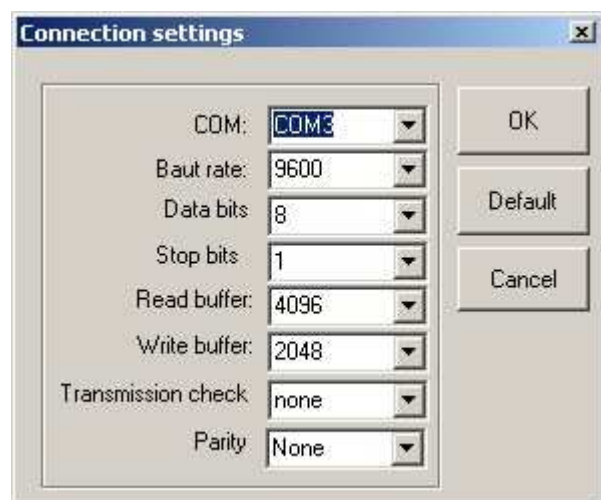

In the menu "Help" you can access the notes for operation and the version information of the device.



Regard! The instructions as well as the version information will be displayed in the text box and replace the actual text in the box (if already displayed). Please note that these will be previously secured if needed!

By clicking the right mouse button on the text box will open a context menu in which the colors of the text and background can be adjusted individually. Please note that the text and the background does not have the same color, because in this case the text is not visible.





[www.CHRONOSKOP.de](http://www.CHRONOSKOP.de)

A device made by PRELIS ELECTRONICS<sup>®</sup>

[www.PRELIS.de](http://www.PRELIS.de)

Owner.: Lukas Lisowski, Dipl. Ing. (FH)

Rudolf-Fendt-Strasse 4

D-63679 Schotten

Tel./Fax: +49 6044 987884

